



**Proto Paintball**

**USA** 10637 Scripps Summit Ct. San Diego, CA 92131  
P 858-536-5183 F 858-536-5191

**EUROPE** Unit 1, ZK Park, 23 Commerce Way  
Croydon, Surrey CRO 4ZS United Kingdom  
P +44 (0) 20-8649-6330 F +44 (0) 20-8649-6339

**ASIA** 3F-2, No. 287, Jung Jeng Rd., Lujun Hsiang  
Taoyuan 338, Taiwan (R.O.C.)  
P +886-3-312-6540 F +886-3-311-8723

[www.protopaintball.com](http://www.protopaintball.com)  
[www.dyematrix.com](http://www.dyematrix.com)

Copyright ©2006 DYE Precision, Inc. The stylized "proto" logo and the "P" logo are either registered trademarks, trademarks, or design trademarks of DYE Precision, Inc.  
Dye Precision, Inc. U.S. Patent # 5,613,483 and additional patents pending.

[WWW.PROTOPAINTBALL.COM](http://WWW.PROTOPAINTBALL.COM)

# M 7 O W N E R ' S M A N U A L

W W W . P R O T O P A I N T B A L L . C O M



## INCLUDED WITH YOUR M7

- M7 Marker
- Allen tool set including 1/16", 5/64", 3/32", 1/8", 5/32", 3/16" and 1/4"
- 1/2 oz. Dye Slick Lube™
- Parts Kit
- Barrel Sock
- Owner's Manual
- Warranty Card

## ADDITIONAL RECOMMENDED TOOLS

- 3/8" Allen wrench
- 5/16" Allen wrench
- Canned Air

# TABLE OF CONTENTS

QUICK REFERENCE .....	PAGE 02
IMPORTANT SAFETY INSTRUCTIONS AND GUIDELINES .....	PAGE 03
BOARD SETTINGS AND FUNCTIONS .....	PAGE 04
TRIGGER ADJUSTMENT .....	PAGE 07
FUSE BOLT .....	PAGE 08
LOW PRESSURE REGULATOR (LPR) .....	PAGE 10
HYPER2™ .....	PAGE 12
ANTI CHOP EYES/ BALL DETENTS .....	PAGE 13
TROUBLE SHOOTING GUIDE .....	PAGE 14
EXPLODED VIEW .....	PAGE 16
WARRANTY INFORMATION .....	PAGE 17

W W W . P R O T O P A I N T B A L L . C O M

# QUICK REFERENCE

## USING YOUR MARKER

**Air Supply** - The M7 should be operated using air/nitrogen gas only. This air needs to be supplied to the Hyper2™ in-line regulator at a regulated pressure of no more than 850 psi. The Hyper2™ in-line regulator comes factory preset at 185psi.

**Gassing Up Your M7** - Screw in your air system to the on/off airport and turn the knob of the airport clockwise, all the way in.

**Turning On Your M7** - The M7's power is controlled by two buttons. The top button turns the marker on and off, while the bottom button turns the eyes on and off. Hold the power button for 3 seconds to turn the marker on. The LED in the grip will illuminate during the boot sequence.

**NOTE: If the eye is not working properly, try replacing the battery.**

<b>Yellow:</b>	- Boot sequence
<b>Red:</b>	- Breech is clear, no ball (eyes on)
<b>Green:</b>	- Ball in breech, ready to fire (eyes on)
Blinking <b>Red:</b>	- Eyes are off
Blinking <b>Green:</b>	- Eye failure (see M7 Board, page 4)

**LPR** - The LPR is pre-set from the factory at approximately 75-80 psi and should need no adjustment out of the box. If fine tuning adjustment is desired or needed, you must be sure that you are adjusting the LPR correctly. See page 11 for detailed instructions. If the LPR is improperly adjusted, you could dramatically hinder the M7's performance or prevent the marker from functioning at all.

**NOTE: Turning the adjustment screw clockwise, or in, will lower the LPR's output pressure. Turning the adjustment screw counterclockwise, or out, will raise the LPR's output pressure.**

**Hopper** - To get the best performance out of your M7, it is recommended that you use a motorized loader. Preferably one that force feeds the paint really, really fast!

**Adjusting Velocity** - The velocity is adjusted through the Hyper2™ in-line regulator. The Hyper2™ in-line is preset from the factory at approximately 185 psi. This pressure setting should have the marker shooting at about 285fps. Your paint-to-barrel fit will also have a noticeable affect on your velocity. Make sure that the paintball fits into the barrel loosely but does not drop through.

**NOTE: For the Hyper2™, turning the adjustment screw clockwise, or in, will lower the output pressure, decreasing the velocity. Turning the adjustment screw counterclockwise, or out, will raise the output pressure, increasing the velocity.**

**If the battery is too low, it may not be able to power the solenoid correctly. This will affect your M7's velocity, causing it to be inconsistent and/or low.**



## IMPORTANT SAFETY INSTRUCTIONS AND GUIDELINES

- The M7 marker is not a toy. Misuse may cause serious injury or death.
- Please read, understand and follow the directions in the M7 owner's manual.
- Eye protection that is designed specifically for paintball and meets ASTM/CE standards must be worn by user and persons within range.
- Recommend 18 years or older to purchase. Person under 18 must have adult supervision.
- Always treat the M7 marker as if it were loaded and able to fire.
- Only use compressed air or nitrogen gas in the M7 marker. DO NOT USE CO<sub>2</sub>.
- Do not exceed 850 psi input pressure.
- Ensure all air lines and fittings are tightened and secured before gassing up the M7.
- Always chronograph the M7 marker before playing paintball.
- Never shoot the M7 marker at velocities in excess of 300 feet per second, or at velocities greater than local or national laws allow.
- Never look into the barrel or breech area of the M7 when the marker is switched on and able to fire.
- Always fit a barrel blocking device to your M7 when not in use on the field of play.
- The owner's manual should always accompany the product for reference or in the event of resale and new ownership.
- Do not point the M7 marker at anything that you do not intend to shoot.
- Do not shoot at people, animals, houses, cars or anything not related to the sport of paintball.
- Do not fire the M7 without the Fuse™ bolt screwed in completely.
- If you read these instructions and do not fully understand them or are unsure of your ability to make necessary adjustments properly, call DYE or your local pro shop for help.



# M7 BOARD

## SETTINGS AND FUNCTIONS

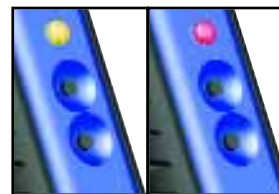

### BUTTONS AND LED INDICATOR

There are two buttons and a LED indicator mounted inside the frame of the M7. These are accessible on the back side of the frame. The top button is used to turn the M7 ON and OFF. The bottom button is used to turn the Eye feature of the M7 ON and OFF. To turn the M7 ON press and hold the top button until the LED turns on. The Eye feature is always on when the M7 is turned on, to turn off the eye feature press and hold the bottom button until the LED starts blinking Red indicating the eye feature is turned off. If there is no ball and the LED is RED, you need to hold the trigger for 1 second to force the M7 to fire once.

In normal operation mode the LED indicator shows you the following information:

**Yellow:** Boot up Sequence

**Red:** No ball detected inside the M7, eyes are turned on

**Green:** Ball detected inside the M7, eyes are turned on

Blinking **Red:** Eyes are turned off

Blinking **Green:** Eyes are blocked. Either the eyes are dirty, the marker is not gassed up, there is bad connection between the board and the eye's or the battery is low.

### SETTINGS AND CONFIGURATION MODE

There are five settings that can be altered in the M7 circuit board.

1. ABS (Anti Bolt Stick) **This helps to prevent bolt stick, but may result in higher velocity for the first shot.**
2. Trigger sensitivity
3. Dwell
4. ROF (Rate Of Fire)
5. Fire Mode

Setting 1, Anti Bolt Stick, is changed by turning DIP switch #1 on the circuit board either ON or OFF. When the ABS is turned on, the dwell is increased after 15 seconds of non-use for the next shot fired. This helps to prevent bolt stick. Factory default is ON. Notice that the setting is only activated after re-starting the M7.

To change settings 2-5 you will need to activate the configuration mode. To activate the configuration mode, turn your marker off, unscrew the two left side grip panel screws with a 3/32" allen key and set DIP switch #2 to the on position. Next, turn your marker on. The 3-color LED will cycle through all colors for one second to indicate that you have entered the configuration mode. To cycle through different settings, pull and release the trigger. Configuration mode has 4 settings that can be changed.

### GREEN - TRIGGER SENSITIVITY. VALUES 1 - 20 (factory default 5)

Trigger sensitivity is the amount of time that the trigger has to be released before the next trigger pull is allowed. In some situations with too low of a value, the marker may begin to shoot full-auto.

### RED - DWELL. VALUES 1 - 40 (factory default 18)

Dwell is the amount of time that the solenoid will be activated. Follow these steps for the best way to set your dwell:

- Remove loader and any paintballs from the M7 marker.
- With the dwell set at 15, start increasing the value until the marker begins to fire.
- When you reach the setting where the marker begins to fire, get some paint and a loader and go to a chronograph.
- Increase the dwell until you see no increase in the velocity. This is the optimal dwell setting to be used.

**NOTE:** The eyes are always activated when you turn the marker on.

**NOTE:** The M7 automatically switches off after 10 minutes of non-use.

# M7 BOARD

## SETTINGS AND FUNCTIONS

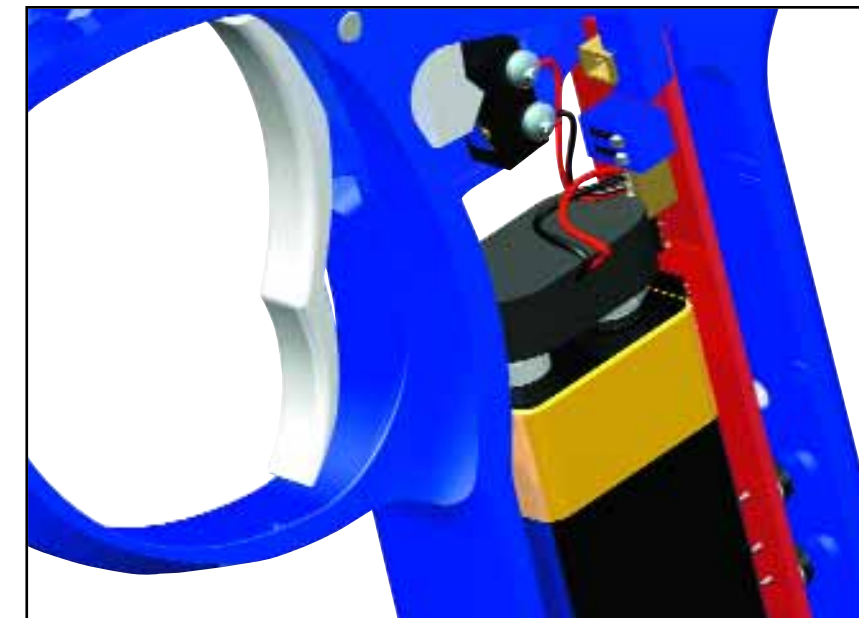

### YELLOW - RATE OF FIRE (VALUES 1-20)

The ROF setting is used to set the maximum rate of fire of the M7. The values do not correspond directly to a certain Balls Per Second (BPS) value. You will need to use the table below to locate your desired maximum ROF setting. The factory default is 15 (20 BPS). This setting is used both when the Eye function is turned on and off.

1	10 BPS	11	15.6 BPS
2	11 BPS	12	15.9 BPS
3	12 BPS	13	16 BPS
4	13 BPS	14	18 BPS
5	14 BPS	15	20 BPS
6	14.5 BPS	16	22 BPS
7	14.7 BPS	17	24 BPS
8	14.9 BPS	18	26 BPS
9	15.2 BPS	19	28 BPS
10	15.4 BPS	20	30 BPS

### FLICKERING YELLOW - FIRE MODE (VALUES 1-3)

The fire mode setting is used to select the fire mode of the M7. Factory default is semi automatic mode; one trigger pull shoots out one paintball. The Millennium mode and the PSP mode follow the rules of the paintball tournament series.

**Value 1** - Semi automatic mode

**Value 2** - PSP mode

**Value 3** - Millennium Mode

### TO CHANGE A VALUE OF A SETTING

1. While in the configuration mode choose the color you wish to change by pulling the trigger.
2. When the LED indicates the color you wish to change pull and hold the trigger until the LED starts to flash.
3. The LED will flash as many times as the previous setting was and it will then turn off. Now pull the trigger as many times as you wish the new setting to be.
4. When done, the LED will cycle through all the colors again to indicate setting was saved and turn back to green. You can now change another setting or quit the configuration mode.
5. To exit configuration mode, set DIP 2 to the off position.



Normal Mode



Configuration Mode

# M7 BOARD

## SETTINGS AND FUNCTIONS

### BATTERY

The 9V battery will last for about 40,000 shots. Please be aware that there are substantial differences in performance between different brands of batteries. Use of high quality alkaline or lithium ion batteries is recommended for maximum battery life. If you plan not to use your marker for a long period of time (a month), it is recommended that you remove the battery from the marker. When the battery voltage starts to go too low, you will notice your velocity starts to decrease and the board can turn off. For tournament use, it is recommended to change the battery for each tournament. When changing your battery, take special care to ensure the wiring harness is not pinched under the battery.

### CHANGING THE BATTERY

The battery is housed on the left side of the grip frame. To access the battery, remove the two screws holding the left side grip panel down. Use a 3/32" Allen wrench. Carefully lift the battery out of the frame, taking care not to damage the battery lead wires. Clip a new battery into the 9V connector and carefully place it back into the frame, making sure that no wires are pinched underneath the battery.



## WARNING

- A low battery will not be able to power both the ACE and the trigger switch, causing ACE failure.
- If the battery is low, it may not be able to power the solenoid correctly. This will affect the M7's velocity, causing it to become inconsistent and/or low.

# TRIGGER ADJUSTMENT

## AND ON/OFF AIRPORT

### ADJUSTING YOUR TRIGGER

The trigger's forward travel and over travel are fully adjustable so that the user can fine-tune the trigger to his or her exact liking.

- Remove the grip frame from the body of the M7.
- As you pull the frame away from the body, take care so as not to damage the wires running between the two parts. Be careful not to lose the trigger spring.
- The two adjustment screws are located at the top of the trigger in the grip frame (see figure 1).
- Use a 5/64" Allen wrench to make the desired adjustments.
- The screw toward the front of the trigger controls the forward travel. Screwing it in will shorten the trigger's length of pull.

Note: If this screw is adjusted too far, the switch will be held down at all times and the marker will not fire.

- The screw toward the rear of the trigger controls the over travel. By turning this screw you can adjust how far the trigger will travel after it reaches the firing point. Note: If this screw is adjusted too far, the trigger will not be allowed to travel far enough to depress the switch and fire the marker.
- When the desired trigger pull has been achieved, reattach the frame to the body.
- Take care that the spring is seated properly. Using the trigger without a spring is not recommended and will cause the microswitch to fail much sooner than when a spring is used.
- Be sure that all wires are laid properly in their appropriate cavities.

NOTE: Be sure that the frame and trigger assembly are kept clean. If there is excess dirt or paint build up around the trigger, the trigger will no longer move freely. In addition, paint and dirt can cause the microswitch to not function properly or fail.

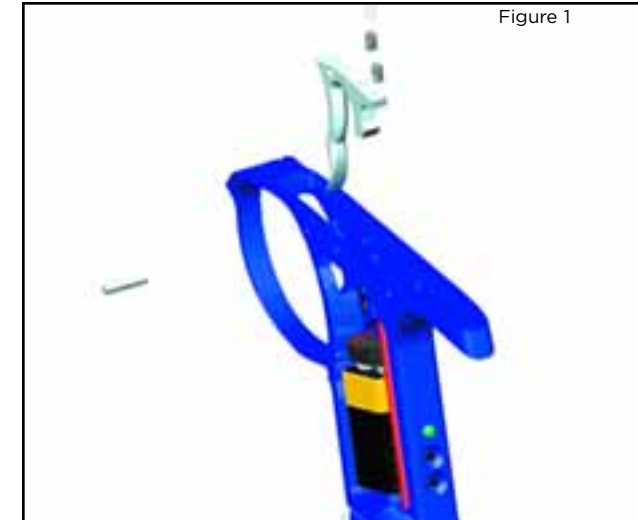

### ON/OFF AIRPORT

The M7 comes equipped with an On/Off Airport attached to the bottom of the frame. To turn on the gas supply, twist the on/off knob clockwise, all the way in. To turn off the gas supply, twist the on/off knob counterclockwise, all the way out. As you turn the knob out, the residual gas between the Hyper2™ and the on/off airport is vented.

### REMOVING THE ON/OFF AIRPORT

- 1 Follow the instructions on page 6 to remove the battery from the frame.
- 2 Using a 3/32" allen key, turn the airport locking screw counterclockwise until the on/off airport is loosened.
- 3 Slide the on/off airport off of the frame.
- 4 To re-install the on/off airport, follow steps 1-3 in reverse order.

## WARNING

- Be sure the trigger is not adjusted to the point where it is too sensitive and may cause accidental discharge of the marker.
- Removing the trigger spring will cause premature wear on the microswitch, resulting in failure.
- **Be sure you do not pinch the wires between the frame and body when reattaching the frame to the body.**

# FUSE™ BOLT

## ASSEMBLY AND MAINTENANCE



### WARNING

When servicing your marker:

- Make sure your hopper is removed from the M7.
- Make sure there are no paintballs in the breech of the M7.
- Always remove the air supply and relieve all gas pressure in the M7 before disassembly.
- When using the M7 in temperatures below 50° it may be necessary to lube the FUSE™ bolt more frequently.

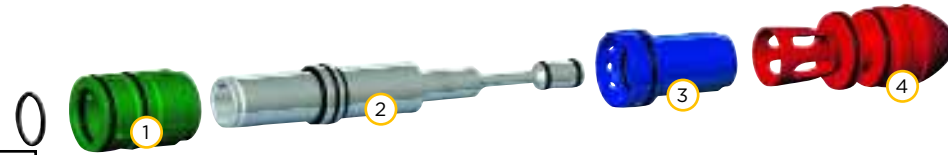

### FUSE™ BOLT OPERATION

To achieve top performance from your M7, it is important to understand the basic operation of the M7's patented FUSE™ bolt system.

This design consists of three sleeves threaded together to capture the only moving part of the system, the bolt.

The FUSE™ Bolt has four components:

- 1 Cylinder
- 2 Bolt
- 3 Top Hat
- 4 Rear Cap

Air is supplied to the bolt at two points. A high-pressure supply of air is routed to the back of the bolt into the supply chamber. This air source is responsible for propelling the ball. Low-pressure air is supplied from the LPR to the solenoid. From the solenoid, the air is routed through two small holes to the section of the bolt referred to as the cylinder.

When the M7 is aired up, air is transferred by the solenoid to the front of the cylinder. This air pushes against the bolt sail and the bolt is held in the back position. When the bolt is held back, the O13 o-ring in the top hat seals around the bolt and contains the air in the supply chamber.

When the marker is fired, the microswitch is pressed, telling the solenoid to switch the flow of air from the front of the cylinder to the rear of the cylinder. Air that enters the rear of the cylinder will push on the bolt sail, moving the bolt forward. The air in the front of the cylinder is vented.

As the bolt moves forward, the tapered stem passes through the top hat. Once the bolt stem can no longer seal against the O13 o-ring, the air contained in the supply chamber is released. The air passes through the venturi ports in the bolt and out the front of the bolt to propel the ball. When the bolt is in the forward position, the inside bolt stem o-ring prevents the flow of air from continuously flowing through the marker when the bolt is forward. This helps the marker shoot much more efficiently.

**NOTE: LOW OR ERRATIC VELOCITY MAY BE DUE TO A LOW BATTERY NOT SUPPLYING AMPLE ELECTRICAL CURRENT TO THE SOLENOID. IN THIS CASE, CHANGE THE BATTERY.**



FORWARD POSITION

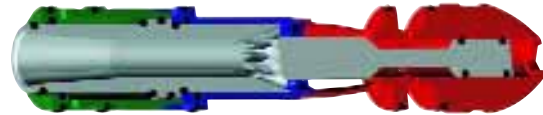

BACK POSITION

# FUSE™ BOLT

## ASSEMBLY AND MAINTENANCE

### BOLT MAINTENANCE

Regular M7 Fuse™ bolt maintenance is vital to the performance of the M7.

If the Fuse™ bolt is not kept well-greased and the o-rings in good shape, the performance of the M7 will be greatly hindered.

To remove the bolt, you will need a 1/4" Allen wrench. Unscrew the bolt from the rear of the marker. It only takes one and one half revolutions to unscrew the bolt so that it can be pulled out. After the bolt has been cleaned and greased and is ready to be inserted into the body, be sure all bolt sleeve components are screwed together snugly. Slowly push the bolt into the body. Take care not to cut or nick the o-rings as they pass the threads.

**GREASE THE M7 FUSE™ BOLT EVERY 10-15 THOUSAND SHOTS.**

**BEFORE INSTALLING THE BOLT INTO THE MARKER, BE SURE ALL BOLT SLEEVE COMPONENTS ARE SCREWED TOGETHER SNUGLY.**

If you do not grease the bolt, you will run the risk of damaging o-rings. This will create excessive friction and drag on the bolt, ultimately resulting in breaking the bolt. When greasing the M7 Fuse™ bolt, pay special attention to all o-rings that are on the bolt and that ride on a surface of the bolt. The first seven o-rings listed below should be generously greased during maintenance.

### FUSE™ BOLT O-RING LIST

- |                                  |                           |
|----------------------------------|---------------------------|
| 1 Bolt tip (014 BN70)            | 6 Top hat (017 UR70)      |
| 2 Bolt sail (015 BN70)           | 7 Top hat (013 BN70)      |
| 3 Inside bolt stem (009 BN70)    | 8 Outer sleeve (020 BN70) |
| 4 Rear bolt stem (009 BN70)      | 9 Front bumper (015 BN70) |
| 5 Front wall internal (017 UR70) | 10 Rear bumper (111 BN70) |

NOTE: All remaining o-rings should have a thin coating of grease as well.

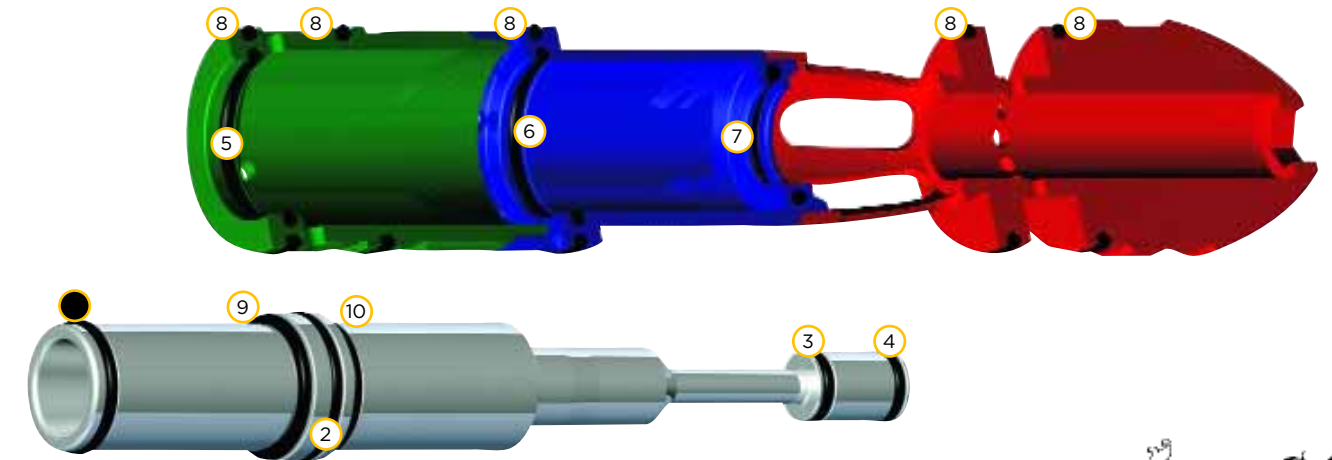

# LPR (LOW PRESSURE REGULATOR)

## ADJUSTMENTS AND MAINTENANCE

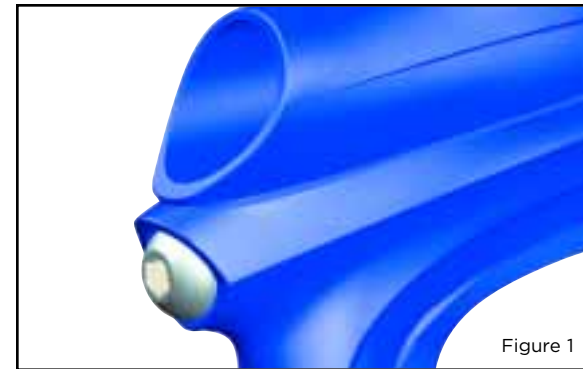

Figure 1

### LPR ASSEMBLY, CLEANING, TESTING AND CHANGING SEALS

The Low-Pressure Regulator (LPR) is located in the lower front of the M7 (see figure 1). The function of the LPR is to lower the air pressure supplied to the marker by the in-line, before it reaches the solenoid. This pressure is used to move the bolt forward and back. The factory setting is 75 PSI. You can fine tune your M7 to its minimum cycle pressure. This will reduce the amount of force of the bolt hitting the ball (reducing ball breaks) and help with efficiency. Too low of pressure will cause the bolt to not cycle, move sluggishly or not at all. If you experience dramatic shoot down during rapid fire, the LPR may be adjusted too low. Too high of pressure will cause the marker not to shoot as smoothly, potentially increase ball breakage and cause undue wear and fatigue on the bolt components.

It is important to keep the seat and piston face clean of all dirt and debris. Clean the seat and piston face and grease the retainer o-ring every six months or 60,000 shots.

The LPR has five components and six seals

- |                                  |   |
|----------------------------------|---|
| 1 Piston large o-ring (O12 BN70) | 6 Piston small o-ring (006 UR90)                        |
| 2 Piston                         | 7 Main seal (mounted in the seal retainer)              |
| 3 Piston spring                  | 8 Seal retainer o-ring (O10 BN70)                       |
| 4 Body                           | 9 Seal retainer (functions as an adjustment screw also) |
| 5 Body o-rings (4pcs, O12 BN70)  |   |

The only user-serviceable part in the LPR is the seal retainer. This seal needs to be changed in the unlikely case the LPR is creeping up.

## WARNING

When servicing your marker:

- Make sure your hopper is removed from the M7.
- Make sure there are no paintballs in the breech of the M7.
- Always remove the air supply and relieve all gas pressure in the M7 before disassembly.
- It is not recommended for the user to remove the LPR from the body and disassemble it.

# LPR (LOW PRESSURE REGULATOR)

## ADJUSTMENTS AND MAINTENANCE

### CHANGING THE SEAL RETAINER

- 1 Screw out LPR cap in front of the marker using a 1/4" Allen wrench.
- 2 Screw out LPR seal assembly (brass) using a 3/16" Allen wrench.
- 3 Screw in new LPR seal assembly.
- 4 Screw LPR cap in place securely.

If the user needs to replace the whole LPR assembly, follow these instructions (refer to figure 2):

- 1 Remove the air supply and relieve all gas pressure from the M7.
- 2 Take the Hyper2 Regulator off the marker (see page 12).
- 3 Screw out LPR set screw using a 5/64" Allen wrench.
- 4 Screw out LPR cap using a 1/4" Allen wrench.
- 5 Pull out the LPR by screwing a rod with a 10/32 thread into the seal retainer (brass piece) and pulling it out.
- 6 Put everything back in reverse order. Be sure to grease the #012 o-rings, so as to prevent cutting them upon installation.
- 7 Tighten LPR cap securely.

The LPR pressure can be set quite accurately even without an LPR test tool. Screwing the adjustment screw (seal retainer) all the way in will set the LPR pressure to approximately 25 psi. Now turning out the adjusting screw 180 degrees will increase the pressure by approximately 5 psi. For example, turning the screw 5 complete turns out will set the pressure to approximately 75 psi. Use a 3/16" Allen wrench to make all adjustments to the LPR. Turning the adjustment screw clockwise, or in, will lower the LPR's output pressure. Turning the adjustment screw counterclockwise, or out, will raise the LPR's output pressure.

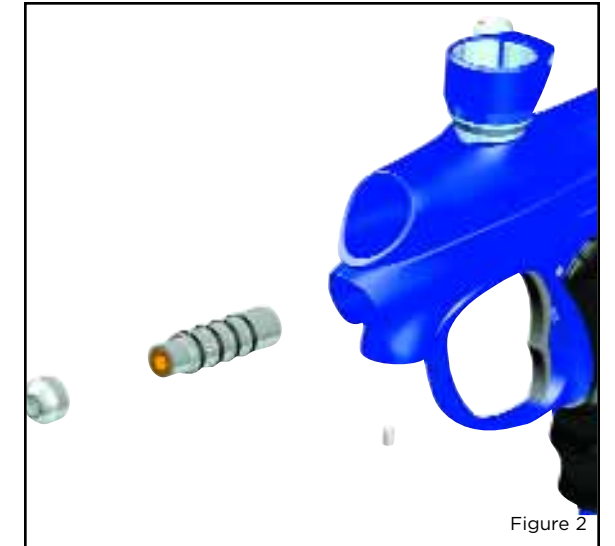

Figure 2



# HYPER2™ IN-LINE REGULATOR

## ADJUSTMENTS AND MAINTENANCE

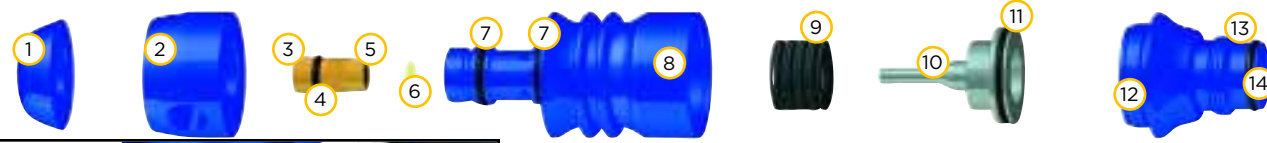

Figure 1

### USAGE

Carefully connect your air hose from your bottle or air system to the Hyper2™ In-Line. The Hyper2™ In-Line is set by the factory to approximately 185psi. This pressure should give you a velocity of approximately 285fps.

### ADJUSTMENTS

The output pressure of the Hyper2™ In-Line is adjusted by turning the brass seat housing. The seat housing screw is located up inside the bottom of the reg. A 3/16" Allen wrench will be needed for this operation. By turning the housing counterclockwise, you will increase the output pressure of the regulator to the marker. By turning the housing clockwise, you will decrease the output pressure of the regulator.

After each adjustment of the output pressure of the Hyper2™ In-Line, you will need to cycle your marker a few times. This will allow your marker and air system to stabilize at their new operating pressure. The Hyper2™ will need a break-in period of about 2,500 shots to let its seat form to the piston and reach its optimum performance.

The Hyper2™ has eight components and six o-rings

1 Retaining cap	6 Piston small o-ring (007 UR90)	11 Piston large o-ring (018 BN70)
2 Swivel	7 Swivel o-rings (013 BN70)	12 Reg cap o-ring (020 BN70)
3 Seat housing	8 Reg body	13 Reg cap
4 Retainer o-ring (010 BN70)	9 Shim stack	14 ASA o-ring (015 BN70)
5 Reg seat	10 Piston	

Disassembly of the Hyper2™ In-Line is easily done with 3/8" and 5/16" Allen wrenches.

### MAINTENANCE

To ensure top performance from the Hyper2™, maintenance should be performed every six months or sooner, depending on the severity of playing conditions. Cold, wet weather will shorten the effective life of the grease. Heavy dust or fine sand can infiltrate the Hyper2™ and prevent the piston from moving smoothly and/or cut the o-rings.

- 1 Make sure the inlet and outlet ports and connecting fittings are free of all dirt and paint.
- 2 Examine all o-rings for nicks or cuts.
- 3 Carefully inspect the seat for excessive wear that might cause spiking and over-pressurizing.
- 4 Clean any accumulated dirt out of the air chambers and passages.
- 5 Keep the piston o-rings and spring pack generously greased to allow smooth velocity adjustment and prevent erratic velocity spikes and drop off.
- 6 Clean off all old grease that may be contaminated with dirt; reapply fresh grease to the piston and other necessary areas.
- 7 Be sure to reassemble the internal components and shim stack (see figure 2) in the proper order and direction.
- 8 See diagram for assistance.

Shim Stack



Figure 2

# ANTI CHOP EYES/ BALL DETENTS

## MAINTENANCE AND CHANGING

### ANTI CHOP EYES

The Anti Chop Eye (ACE) system will prevent the M7 from chopping paint by not allowing the marker to fire until a ball is fully seated in front of the bolt. The eyes use a beam across the breech. On one side there is a transmitter, and on the opposite side a receiver. In order for the marker to fire with the eyes turned on, the signal between the two eyes must be broken. After every shot, before the next ball drops in the breech, the eye transmitter and receiver must see each other. If the eyes are dirty and cannot see each other between shots, the LED on the board will start blinking green. This means that the eyes are dirty. This is an extremely reliable system as long as the eyes are kept clean. The most common reason for dirty eyes is broken paint. If the eyes become dirty the marker will default to a reduced rate of fire to prevent chopping. If this happens during game play, you can bypass this by turning the eyes off. Clean the eyes as soon as possible.

**NOTE: IF THE BATTERY IS LOW, THE MARKER MAY ACT AS IF THE EYES ARE DIRTY OR NOT FIRE AT ALL. IN THIS CASE, REPLACE THE BATTERY.**

### CLEANING THE ANTI CHOP EYES

Quite often, just cleaning the breech out with a swab will clean the eyes well enough for them to read one another. For a thorough cleaning, the best method is to use air. Using an air hose or canned air (typically used for dusting keyboards) works best.

Blow the eyes clean from inside the breech. If you feel the eyes still need a more detailed cleaning, remove the eye covers to gain full access to the eyes.

To remove the eye covers, you will need a 1/16" Allen wrench.

Simply insert the allen wrench into the hole in the eye cover to access the retaining screw (see figure 3). As you back out the screw, the plate will be pushed up.

NOTE: Regular eye cleaning is recommended even if no paint is broken. Clean the eyes every two months or 10,000 shots to eliminate any built up dirt. Excess grease from the front bolt o-ring can build up in front of the eyes. Remember to check for this after greasing the bolt and cycling the marker a few times.

### CHANGING BALL DETENTS

The ball detents are also located under the eye covers. If you are experiencing double feeding or chopping, check the condition of the ball detents. They should come to a soft point. If they are flat or heavily rounded, they should be replaced. Ball detents should be replaced about every 40,000 shots.

**NOTE: TAKE CARE WHEN REPLACING THE EYE COVERS. OVER-TIGHTENING THE RETAINING SCREW COULD RESULT IN STRIPPING THE THREADS.**

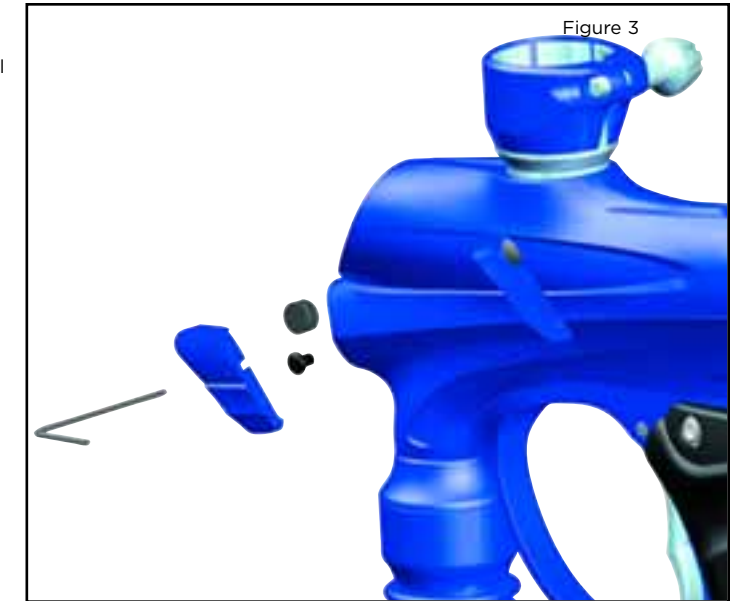

Figure 3

## WARNING

- The Hyper2™ can hold a small residual charge of gas, typically 1 shot. Always discharge the marker in a safe direction to relieve this residual gas pressure.
- Always remove the regulator from the M7 before servicing.
- Improper stacking of shims will cause failure of the regulator and possible damage to the M7.
- Excessive dirt and debris can affect the Hyper2™'s performance and increase the need for servicing.



# TROUBLE SHOOTING GUIDE

## AIR LEAKS

### AIR LEAKING FROM THE AIRPORT

- Check the o-ring on the Air system. If needed change the o-ring and try again. The o-ring normally used is #15 but some manufacturers might use a different size. Consult the manual of the air system you are using.
- Check that the hose connector is tight. Remove the hose from the connector by pushing the gray plastic towards the connector and pull out hose. Insert a 3/16" allen key into the connector and tighten. If needed remove and apply thread sealant to the thread and re-tighten. If unsure consult expert advice.
- Check that the end of the hose is cut straight and is not worn out. If needed cut a small piece off the hose with a razor blade and re-insert hose into the fitting. Make sure hose goes all the way to the end.

### AIR LEAKING FROM THE HYPER2 REGULATOR

- First locate the position of the leak.
- For dis-assembly instructions consult the technical section under Hyper2 regulator.
- If the leak is coming from the bottom of the regulator you will need to dis-assemble the regulator and change the #010 O-ring and the seat on the brass seat retainer mounted inside the Hyper2 regulator.
- If the leak is coming from the swivel piece where the hose connector mounts you will need to change the two #013 o-rings under the swivel piece or tighten the hose connector.
- If the leak comes from the small hole in the middle of the regulator there are two possible o-rings causing the problem. Change the #020 o-ring on the piston and the #007 urethane o-ring inside the body of the regulator.
- If the leak is from the top of the regulator, change the #015 o-ring on the outside of the cap.

### AIR LEAKING FROM THE ASA

- First make sure that the ASA is tightened well into the body of the M7 by removing the Hyper2 regulator and tightening the ASA screw with a 3/16" Allen key.
- Next change the #015 o-ring on the top cap of the Hyper2 and apply a small amount of lube to the o-ring.
- Finally, if above steps don't help, remove the ASA with a 3/16" allen key and change the #012 o-ring mounted on the top of the ASA. Apply a small amount of lube and tighten back together.

### AIR LEAKING BETWEEN BODY AND FRAME

- Leak between the body and the frame can be caused by a couple of things
- First pull out the Bolt kit and change the #015 sail o-ring and the 2 #020 o-rings on the outside of the cylinder.

- If above doesn't help, remove the frame from the M7 and remove the solenoid by unscrewing the two screws mounting it down. Apply some lube to the seat underneath the solenoid and re-assemble making sure that the solenoid is well tightened into the body and that the eye wire is not pinched underneath the solenoid.
- Last possibility is that one of the gas passages is leaking. Gas up the M7 without the frame attached and try to locate the exact point of leakage. If leak is coming from one of the blocked holes remove the screw, apply some thread sealant and re-attach screw to the body.

### AIR LEAKING FROM BACK OF THE M7

- Check that the bolt kit is tightened all the way into the M7. If the bolt kit is loose, it will start to leak.
- If above does not solve the leak, remove the bolt kit and change the #020 o-ring on the back part of the bolt. Also change the two #009 o-rings located in the stem of the bolt. Lube well and re-insert the bolt kit into the M7. Check bolt kit break down picture on page 9 for o-ring locations.
- Last, check that the gas passage blocking screw located on the center of the M7 is not leaking. If the leak is coming from this hole, remove screw and apply thread sealant to it. Make sure to tighten screw well and wait for sealant to dry before re-gassing marker.

### AIR LEAKING FROM FRONT OF THE M7

- Remove the Bolt kit from the marker and change the #017 o-ring located inside of the cylinder and the #013 o-ring located inside the tophat. Lube well and re-assemble.
- If above doesn't help try changing the #020 o-rings located outside of the cylinder. Lube well before re-inserting bolt kit.

## PROBLEMS WITH ELECTRONICS

### M7 WON'T TURN ON

- Make sure battery is new and well charged.
- Check that battery is connected to the 9V clip inside the M7 and that the other end of the 9V harness is connected to the board.
- Make sure there is no dirt or debris blocking the button from being pressed.

### M7 WILL TURN ON / OFF BY ITSELF OR THE EYES WILL TURN ON / OFF BY THEMSELVES

- Both of these problems are caused because the button(s) are pressed all the time.
- Remove board from the frame by removing the grip panel on the left hand side, disconnecting the cables and pulling the board out. Carefully remove the two buttons and clean them well.

- Re-assemble and test. If problems persist, contact authorized service center for board replacement.

### EYES WILL NOT WORK, LED KEEPS BLINKING GREEN

- First change the battery. The eyes are normally the first thing to stop working when a battery is dying.
- Next try to clean the eyes. You can either use canned air and blow out the eye holes through the feed neck hole or remove the eye plates with a 1/16" Allen key, pull out the eyes from the mounting holes carefully and clean them with q-tips. To test if the eyes work, make sure there is nothing inside the breech and that the bolt is in the back position. Turn on the M7, the light should be red after the boot up sequence. If it is, the eyes are working.
- Check that the eye wire is connected to the board so that metal clips are facing down.
- If nothing above helps contact a store or DYE Precision for eye replacement.

### SOLENOID WILL NOT ACTIVATE / TRIGGER NOT WORKING

- Check that the trigger adjustment is not set so that the microswitch cannot activate. You should hear a small click when pulling the trigger.
- If the M7 fires once when turned on but not after that, your trigger is set so that the microswitch is always activated. Re-adjust the trigger.
- If the trigger is correctly adjusted but the M7 still won't fire check that the microswitch cable is well inserted into the board and to the correct connector (the microswitch connector is marked with the text "SW1" on the board).
- Change the battery if not positive about it's charge.
- Check that the solenoid cable is attached to the board and to the right connector (solenoid should be attached to the connector that is marked with the text "SOL").

### TRIGGER BOUNCE / M7 SHOOTING MORE THAN ONE BALL PER PULL IN SEMI AUTOMATIC MODE

- Raise the trigger sensitivity level in the configuration mode.
- Check that the trigger is not adjusted too short.
- Make sure there is a trigger spring inside the frame .

### ERRATIC VELOCITY / M7 WON'T FIRE

### M7 FIRES BUT BALLS ARE DROPPING OFF OR NOT EVEN COMING OUT OF THE BARREL

- Make sure the battery is good.
- Raise the dwell to factory level (25).
- Make sure bolt is well lubed and moves well. If there is too much friction in the bolt it will cause the M7 to shoot down.
- Make sure air system is screwed in all the way.

### FIRST SHOT IS TOO HIGH

- Change the seat inside the Hyper2 Regulator. For dis-assembly instructions consult the technical section.
- Check that the #013 o-ring on the inside of the tophat is in place and in good condition.
- Try turning off the ABS feature by turning DIP #1 to the off position.

### VELOCITY IS NOT CONSISTENT

- Make sure the paintballs you are using fit the barrel good and are consistent in size. The stock barrel with the M7 is .690 size. You should be able to blow the paintball through the barrel but they should not roll through the barrel on their own.
- Remove the bolt kit and re-lube it. Change any o-rings causing a lot of friction. Make sure #014 o-ring in bolt tip is in place and in good condition.
- Raise the dwell.
- Change the battery.
- Check that the Hyper2 regulator is working good and that the pressure is consistent. A separate regulator testing tool is available for this. If needed, dis-assemble and change worn out o-rings in the Hyper2 regulator.

## OTHER CATEGORIES

### DOUBLE FEEDING

- If you get two balls firing at once change the ball detents by removing the eye plates, taking out the old ball detents and inserting new ones.

### BREAKING PAINT

- Make sure you use high quality paintballs and that they are stored according to the manufacturers instructions.
- Check that #14 o-ring on bolt tip is in place and in good condition.
- Make sure your loader is working good and that the rate of fire is not set higher than the maximum feed rate of the loader.
- Check that the barrel you are using is not too tight for the paintballs you are using.

# M7 EXPLODED VIEW

## PARTS LIST

- 1 Clamping Feed Neck
- 2 Ball Detent
- 3 Eye Cover
- 4 Hyper2™
- 5 Anti Chop Eye (ACE)
- 6 Solenoid
- 7 Front Frame Screw
- 8 45 Frame
- 9 Rear Frame Screw
- 10 FUSE™ Bolt
- 11 M7 Body
- 12 Eye Cover Screw
- 13 Airport
- 14 LPR
- 15 LPR Cap



# M7 WARRANTY INFORMATION

## Warranty and legal information

### WARRANTY

DYE Precision, Inc. Warrants for one year to the initial retail purchaser, from the initial date of purchase, that the paintball marker and regulator are free from defects in materials and workmanship, subject to the requirements, disclaimers and limitations of this warranty. Disposable parts, normal maintenance and standard wear and tear parts such as batteries, o-rings and seals are not warrantied. The solenoid and electronic components on the marker are warrantied for six months. This warranty does not cover scratches, nicks, improper disassembly, improper re-assembly, misuse, neglect or improper storage. Modification to the product will void the warranty. The only authorized lubricant for the marker is Slick Lube™. Use of any other lubricant will void your warranty. This warranty is limited to repair or replacement of defective parts with the customer to pay shipping costs. Warranty card and proof of purchase must be submitted to DYE Precision for warranty to be in effect. This warranty is not transferable. This warranty does not cover performance. Paintball markers are non-refundable.

### TECHNICAL SUPPORT

Our Technical Support Department is open Monday through Friday, from 9am to 5pm, PST, and can be reached at 858-536-5183. Additional support and international contacts are available through our web site, [www.protopaintball.com](http://www.protopaintball.com).

### DISCLAIMER

The specifications & photographs in this material are for information and general guidance purposes only. Our products are continually updated and changes may be made to specification, design or appearance from time to time. These are subject to change without notice. Contents of box may therefore vary from owner's manual. For details of changes in design, specification or appearance consult your local distributor or dealer. The FUSE™ BOLT and Slick Lube™ are registered trademarks. Design rights, copyrights and all other rights reserved. All patterns, drawings, photographs, instructions or manuals remain the intellectual property of the manufacturer.

Covered by one or more of the following U.S. Patents: 5,613,483; 5,881,707; 5,967,133; 6,035,843, 6,474,326 and additional patents pending.

All rights will be strictly enforced.

DYE Precision, Inc.  
10637 Scripps Summit Ct.  
San Diego, CA. 92131