

SMART PARTS



Max-Flo™ Regulator

Operating and Maintenance Manual for:

3000 psi Max-Flo™ System

4500 psi Max-Flo™ System

Impulse™ / Shocker™ Regulator

100 Station Street • Loyalhanna, PA 15661
Telephone 724.539.2660 • Fax 724.539.2298
support@smartparts.com • www.smartparts.com

- IMPORTANT -
Please Read Before Use

- Do not repair or replace a ruptured burst disc. Contact a certified airsmith for replacement.
- Do not remove the bottle from the manifold/regulator.
- Empty the air system completely before transporting.
- Do not fill a scratched or damaged air system.
- Do not fill the air system above its specified fill limit marked on the system's bottle.

[Max-Flo Air System]

Your Max Flo™ Regulator is the second generation of Max Flo™ regulators. It has an improved seal design to help prevent leaks and a guiding feature that reduces eccentricity of the internal parts, which can cause leaking.

[NOTE] - When turning on the system, turn the on/off valve slowly, allowing a small amount of air to pressurize the regulator. Continue turning the on/off valve until it is in the “on” position.

Marker Pressure Settings

Following the charts below, set your operating pressure to the required range. The high and low pressure systems are NOT interchangeable and the correct system is necessary to achieve the required pressure setting.

Low Pressure System - This system is for markers that require an operating pressure of 130 to 200 psi. There is a relief valve that purges excess pressure at 240 psi.

High Pressure System - This system is for markers that require an operating pressure of 300 to 1000 psi. There are two pressure springs included that regulate at a mid and high pressure range. Please see the chart below for the correct spring to use with your marker. The system comes with the high-pressure range spring installed and the mid-pressure range spring packaged separately in the box.

Low Pressure System

Shocker: 160-200 psi
Impulse: 130-200 psi

[Depending on the velocity of your marker.]

High Pressure System

Angel:	800 psi	(high pressure spring)
Automag:	900 psi	(high pressure spring)
Automag RT:	700 psi	(high pressure spring)
Autococker:	550 psi	(mid pressure spring)
Evo X Autococker:	450 psi	(mid pressure spring)
BushMaster:	425 psi	(mid pressure spring)

Setting the Operating Pressure

1. Fill your Max-Flo System. Be sure the on/off assembly is in the “off” position. (See Figure 1.0)
2. Connect the outlet side to a marker or pressure stop.
3. Pressurize the regulator by turning the on/off assembly slowly to the “on” position. (See Figure 1.0)
4. To increase the pressure on your regulator, turn the spring cap inward (clockwise) . Adjust the regulator until you achieve the desired pressure.
5. To decrease the pressure on your regulator, turn the spring cap outward (counter clockwise). Adjust the regulator until you achieve the desired pressure.
6. Once your regulator is set to the desired pressure, you can lock- it down by tightening the spring cap locking screw [774].

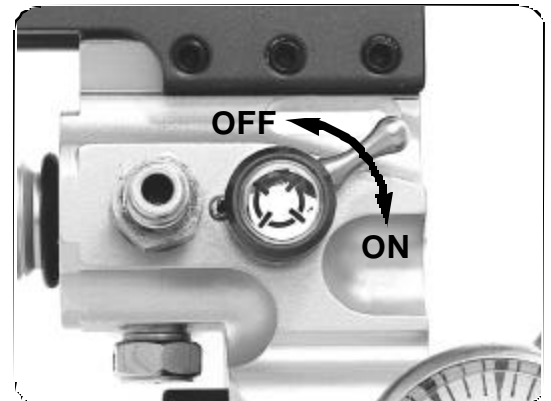

Figure 1.0 - On/Off Assembly

[Max-Flo 4500 psi Air System]

Figure 2.1 - Side View

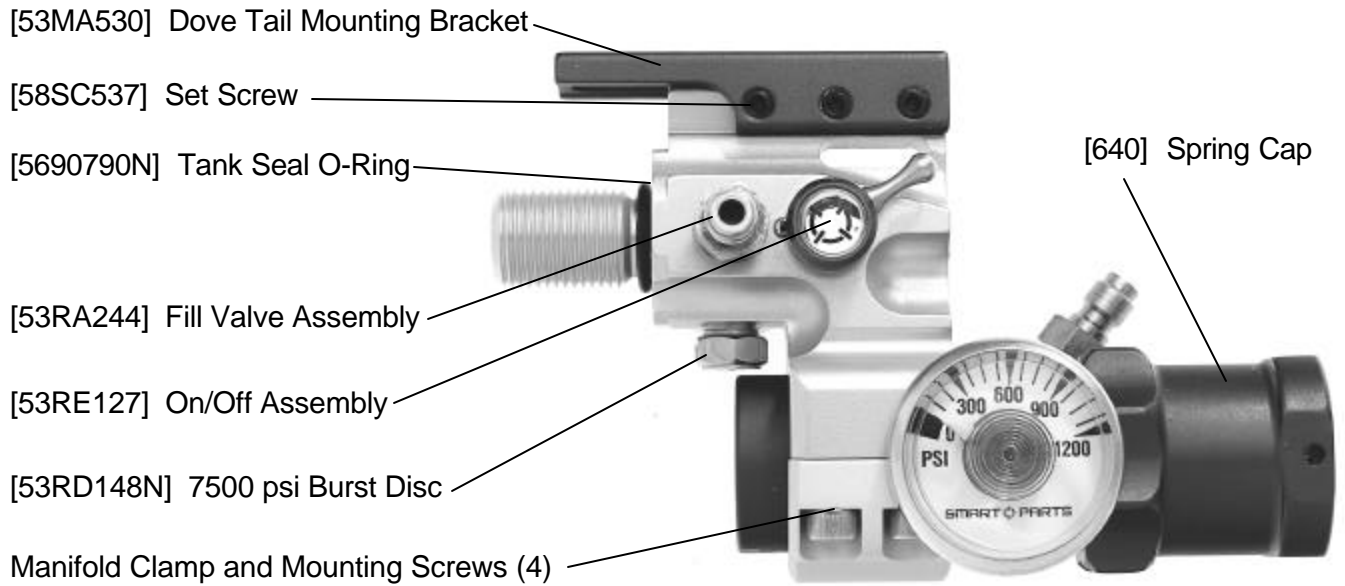
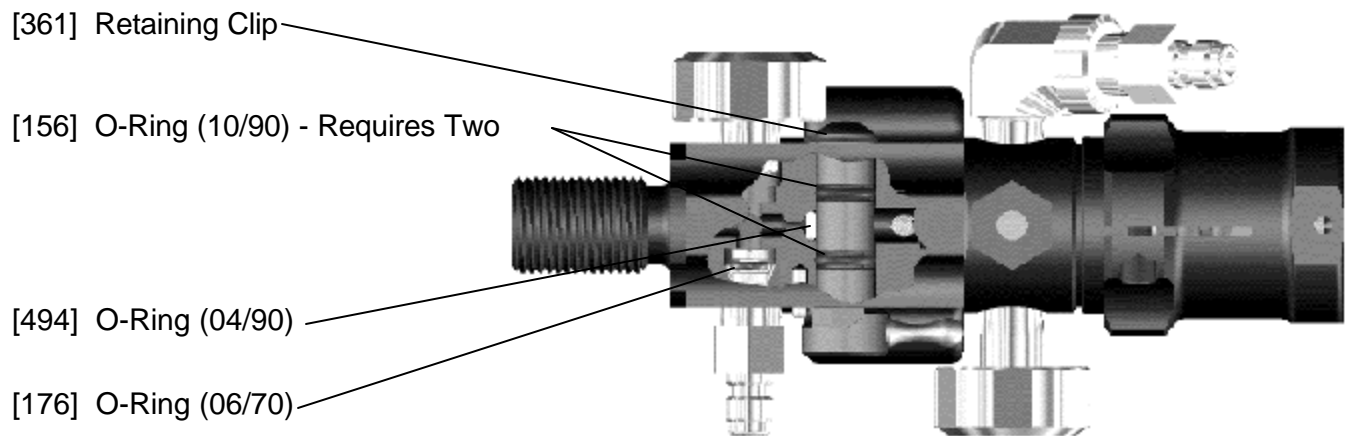
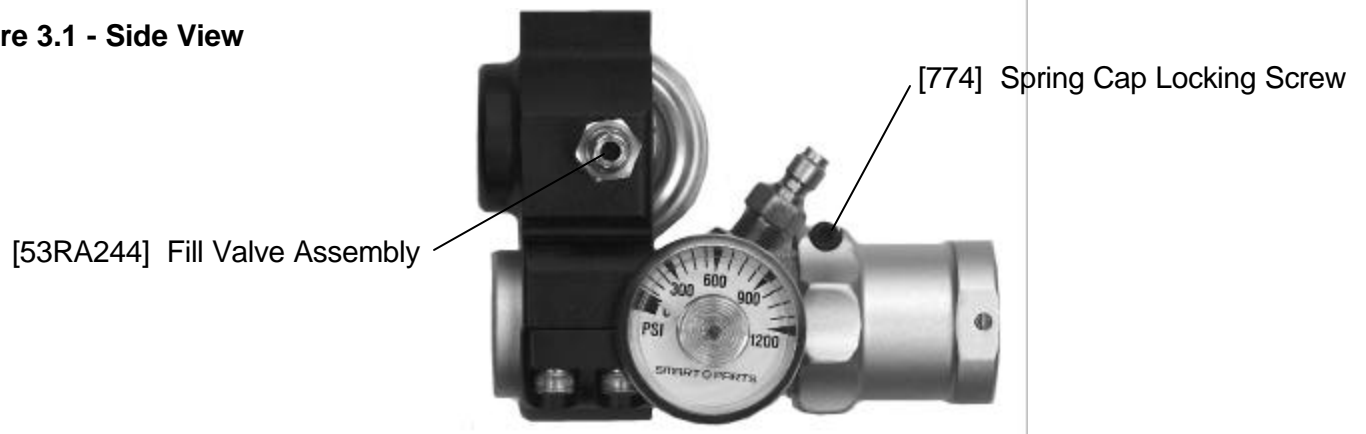

Figure 2.2 - Cut Away Over View



[Max-Flo 3000 psi Air System]

Figure 3.1 - Side View



Bottle Weights

Filled bottles (that is the weight of the bottle filled with CO₂) should be as follows:

- 20oz: 3 pounds
- 68 ci: 4 pounds
- 114 ci: 6 pounds

[Normal Maintenance Procedures]

[NOTE] - Most Max-Flo problems can be solved by a simple cleaning of the regulator.

1. Before disassembling de-gas air system.
2. Remove four screws that attach manifold clamp to manifold and detach regulator.
3. Cleaning the regulator only requires the removal of the o-rings and parts to wipe them off. Dow 33 lubricant should be used on the following: o-rings 540, 231,50 and 343. All other parts should be assembled clean and dry without any lubricant.

[Fixing a Leaking Regulator]

Tools you will need

- 3/8" Allen wrench
- 1-1/4" wrench
- cotton swabs
- low temperature Dow 33 lubricant
- denatured alcohol
- curved dental pick

Step 1 - Testing the Regulator

- a. Pressurize the regulator by turning the on/off assembly to the "on" position. (See *Figure 1.0*)
- b. Check the regulator for leaks.
 - 1) Listen for audible leaks.
 - 2) Apply water to top vent hole of spring cap [640]
- c. If you hear a leak or bubbles appear then de-gas the regulator and proceed to Step 2.

Step 2 - Output Stage Leak:

- a. Remove the spring cap [640] and parts 222,223,230,227 and 219. (See diagram on page 5)
- b. Remove and clean piston [532] or [215].
- c. Pressurize the regulator.
- d. Apply water inside the piston housing on the regulator body [531].
- e. If air leaks clean or replace seals 233 and 46. Also inspect parts 205, 203 and 204 for visible nicks or scratches. Replace if needed.
- f. Reassemble and test regulator. If leak persists, proceed to step 3.

Step 3 - Input Stage Leak

- a. Remove the retaining nut [212] and parts 209, 50, 231, 207, 211, 206, 205, 203, 233, 204 and 46.
- b. Thoroughly clean regulator body [531]
- c. Wipe clean all removed parts and seals. Inspect for nicks or scratches. Replace if needed.
- d. Reassemble with regulator body facing down. (spring cap on bottom)
- e. Reassemble and test regulator. If leak persists, repeat steps 2 and 3, then call tech support.

[Max-Flo Air System Troubleshooting]

Problem: Regulator leaks out of the top of the spring cap.

or

Output pressure slowly climbs above set pressure.

Solution: Clean base seal o-ring [46] and poppet seal o-ring [233]. Reassemble without lubricant.

Problem: Air continues to pass through manifold with on/off valve in off position.

Solution: Replace on/off o-ring [494]. Reassemble with lubricant.

Problem: Regulator vents air from spring cap while firing marker.

Solution:

- Anti-syphon tube on C02 bottle is incorrectly installed or positioned.
- C02 bottle is over-filled.
- Playing in cold weather conditions

Max-Flo Regulator Parts List & Assembly Guide



Alternate Piston

[215] High Pressure Piston
[343] O-Ring (12/90)

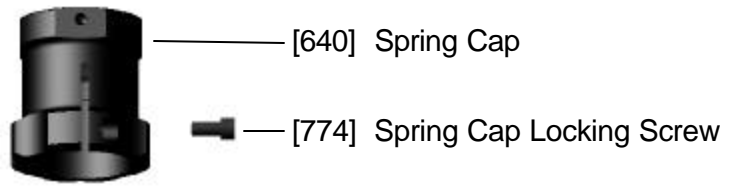

[640] Spring Cap
[774] Spring Cap Locking Screw

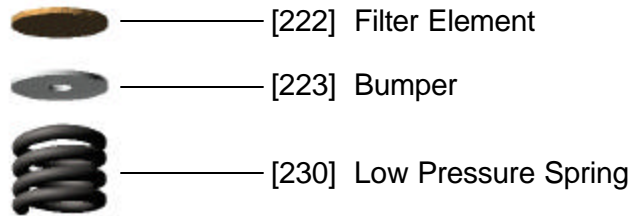

[222] Filter Element
[223] Bumper
[230] Low Pressure Spring

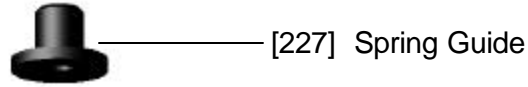

[227] Spring Guide

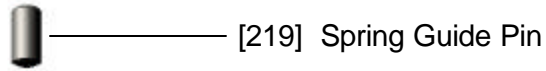

[219] Spring Guide Pin

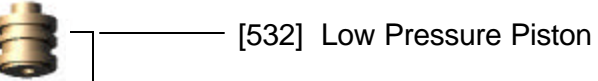

[532] Low Pressure Piston

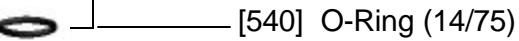

[540] O-Ring (14/75)

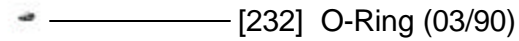

[232] O-Ring (03/90)

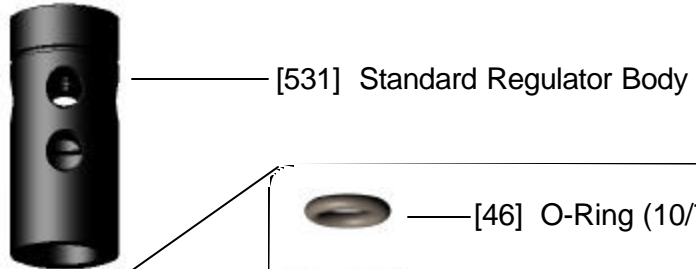

[531] Standard Regulator Body

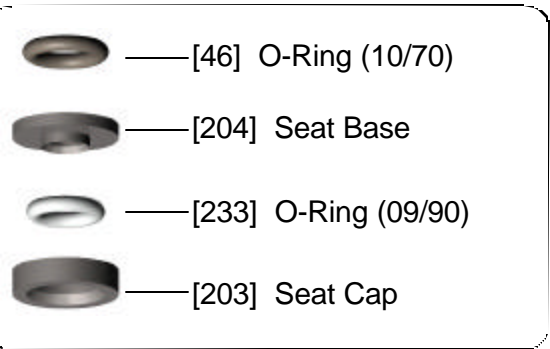

[46] O-Ring (10/70)
[204] Seat Base
[233] O-Ring (09/90)
[203] Seat Cap

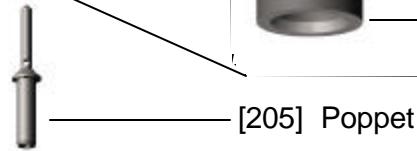

[205] Poppet

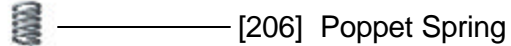

[206] Poppet Spring

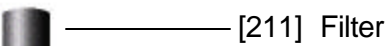

[211] Filter



[207] Spring Retainer

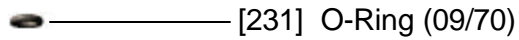

[231] O-Ring (09/70)

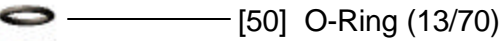

[50] O-Ring (13/70)

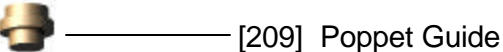

[209] Poppet Guide

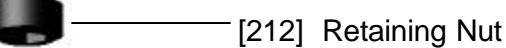

[212] Retaining Nut

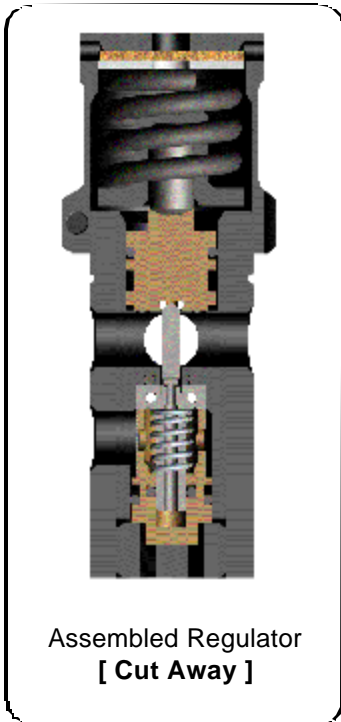

Assembled Regulator
[Cut Away]

Limited Warranty

Smart Parts, Inc. warrants that the Max Flo™ Regulator is free from defects in materials and workmanship for a period of one (1) year from the original date of purchase. This warranty is limited to repair or replacement of defective parts. For this warranty to be effective, the customer must return the warranty registration card within thirty (30) days of purchase.

This warranty does not cover surface damage (scratches and nicks), misuse of the regulator, improper disassembly and re-assembly procedures or normal repair parts such as worn seals, gauges or springs. It is recommended that repairs be made by Smart Parts, Inc.

Carleton Technologies Inc.

Pressure Technology Division

501 McCormick Drive

Glen Burns, MD 21061

Telephone: 410-760-9856

Fax: 410-760-9853

SAFETY BULLETIN 99-01

To all users of composite fiber-wrap paintball cylinders.

Fast filling of cylinders results in heating of the gas and cylinder. If filled too fast, this heat can become excessive and result in damaging the cylinder. Such damage can lead to failure of the cylinder, causing potential property damage and personal injury. Care must be taken to fill the cylinder at a rate so the cylinder temperature does not exceed 140 degrees F.

Prior to each filling, the cylinder should also be examined for signs of damage, including heat/flame exposure. If any damage is observed, do not fill the cylinder. Take the suspect cylinder to a DOT authorized hydrostatic tester for inspection and pressure testing.

Any questions concerning the safe filling or use of these fiber-wrapped cylinders should be directed to the Customer Service Department at Carleton Technologies, Pressure Technology Division, phone 410-760-9856.

SMART PARTS

100 Station Street • Loyahanna, PA 15661
Telephone 724.539.2660 • Fax 724.539.2298
support@smartparts.com • www.smartparts.com